

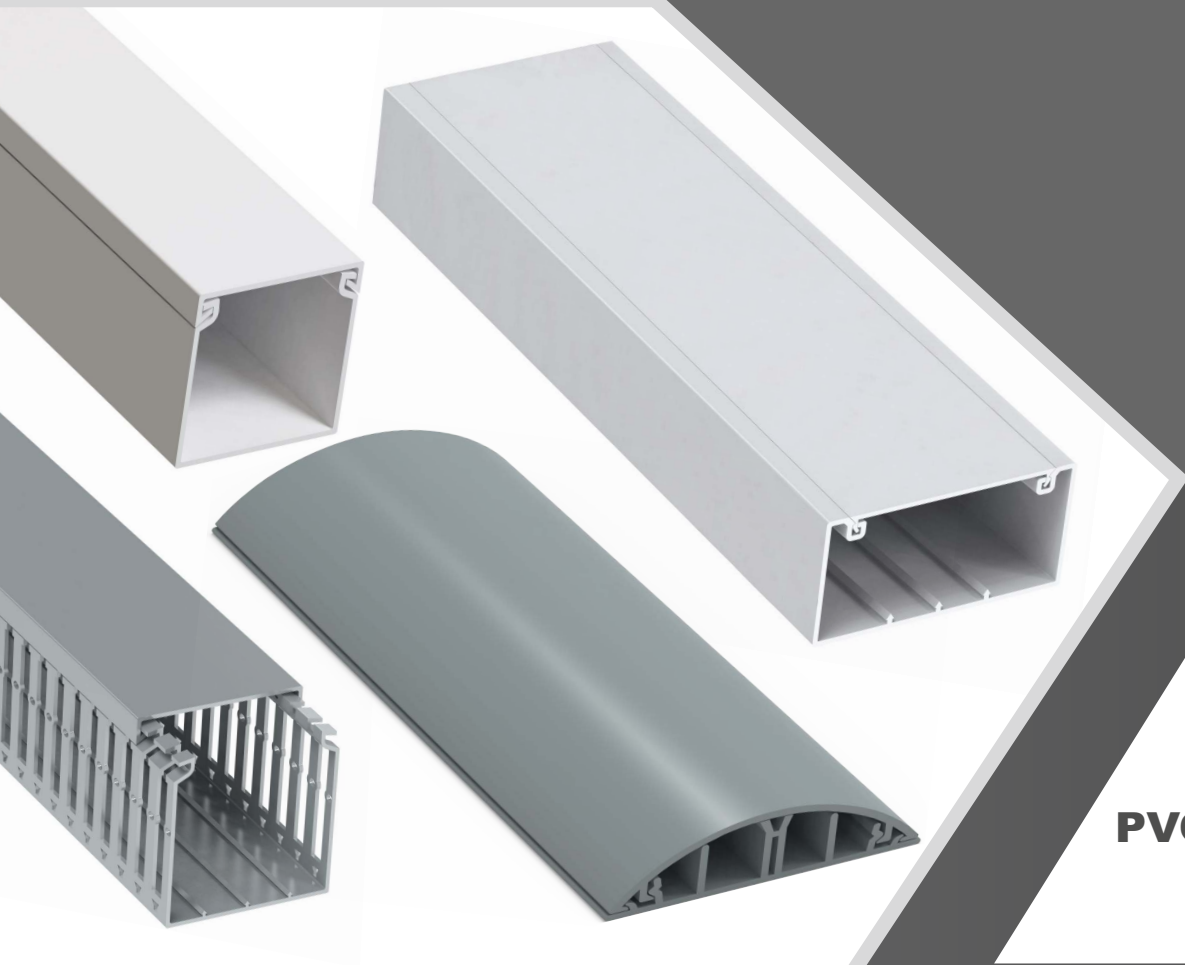

ЕНЕРДЖИ ГРУП ООД

Пластмасови кабелни скарни



PVC CABLE TRAYS

Системи за електрически кабелни скарни

www.abelectric.bg
www.abenergygroup.bg

PVC Trunking

PVC кабелни скари

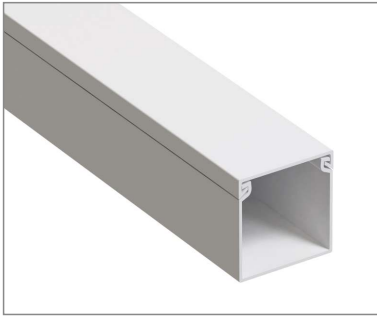

PT...						
CODE	SIZE	Length	PACKAGING TYPE	IN PACK QUANTITY	VOLUME OF PACK	WEIGHT OF PACK
	EBAT	UZUNLUK				
	mm	mm		m	m ³	kg
PT 1212	12x12	2000	in box	360	0,063	20,9
PT 1510	15x10	2000	in box	320	0,067	19,7
PT 1616	16x16	2000	in box	304	0,091	21,8
PT 2010	20x10	2000	in box	264	0,067	22,5
PT 2013	20x13	2000	in box	240	0,080	20,5
PT 2020	20x20	2000	in box	192	0,091	21,1
PT 2516	25x16	2000	in box	168	0,091	20,9
PT 2525	25x25	2000	in box	130	0,100	20,0
PT 3020	30x20	2000	in box	120	0,091	19,1
PT 4016	40x16	2000	in box	112	0,091	21,3
PT 4025	40x25	2000	in box	80	0,100	18,3
PT 4040	40x40	2000	in box	72	0,091	20,9
PT 6040	60x40	2000	in box	48	0,091	20,1
PT 6060	60x60	2000	in box	40	0,100	20,3
PT 8040	80x40	2000	in box	36	0,091	19,3
PT 8060	80x60	2000	in box	32	0,100	20,1
PT 10040	100x40	2000	in box	28	0,091	21,1
PT 10060	100x60	2000	in box	24	0,100	20,8
PT 12060	120x60	2000	in box	20	0,100	21,9

Adhesive PVC Trunking

PVC кабелни скари (с лепило)

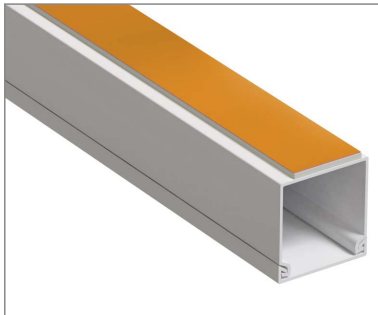

APT S...						
CODE	SIZE	Length	PACKAGING TYPE	IN PACK QUANTITY	VOLUME OF PACK	WEIGHT OF PACK
	EBAT	UZUNLUK				
	mm	mm		m	m ³	kg
APT 1212 S	12x12	2000	in box	360	0,063	21,4
APT 1510 S	15x10	2000	in box	320	0,067	20,3
APT 1616 S	16x16	2000	in box	266	0,091	22,3
APT 2010 S	20x10	2000	in box	240	0,067	23,0
APT 2013 S	20x13	2000	in box	240	0,080	21,0
APT 2020 S	20x20	2000	in box	192	0,091	21,8
APT 2516 S	25x16	2000	in box	168	0,091	21,5
APT 2525 S	25x25	2000	in box	130	0,100	20,5
APT 3020 S	30x20	2000	in box	120	0,091	19,6
APT 4016 S	40x16	2000	in box	112	0,091	21,9
APT 4025 S	40x25	2000	in box	80	0,100	18,7
APT 4040 S	40x40	2000	in box	72	0,091	21,3
APT 6040 S	60x40	2000	in box	48	0,091	20,6
APT 6060 S	60x60	2000	in box	40	0,100	20,7

PT...

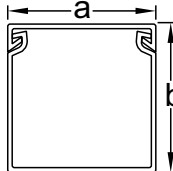
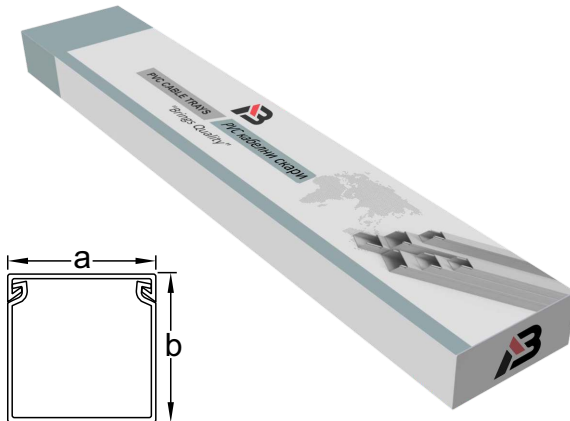

ЕНЕРДЖИ ГРУП ООД		ЕНЕРДЖИ ГРУП ООД	
Ürün Kodu Code of Item Код Продукта	PT 1212		21,79 kg
Ölçü Size Размер	12*12 mm		
Adet Quantity Количество	378 mt	PVC Kablo Kanalı PVC cable trunking Пластиковые короба	
Ticari Ağırlığı Box Weight Вес в Коробке	21,79 kg	Kutu in box в коробе	
Ürün adı Description Описание	12 X 12		

General features

Row Material PVC UL94, V0 M1
Impact Resistance : 2 Joule
Operation Temperature : -25 +65 Co
Colour : White RAL 9010
IP Ingress Protection : IP40

Additional Features

UV resistant
Easy install, paintable, non-flammable,
Economic and adaptable
Resistant to acids, oils and greases
Non-conductive
Nonflammable

Important:

The label size area of Ab group cable trunking **without adhesive tape** is GRAY on the box.

PT... S

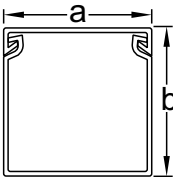
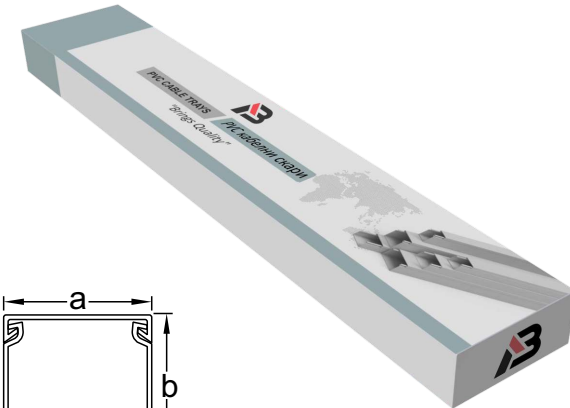

Product with yellow adhesive / Carton box

ЕНЕРДЖИ ГРУП ООД		ЕНЕРДЖИ ГРУП ООД	
Ürün Kodu Code Of Item	APT 25X16 S		20,1 kg
Ölçü Size	25X16		
Adet Quantity	168 mt	PVC Kablo Kanalı PVC Cable Trunking	
Koli Ağırlığı Box Weight	20,1 kg	Kutu In Box	
Ürün adı Description	25x16		

General features

Row Material PVC UL94, V0 M1
Impact Resistance : 2 Joule
Operation Temperature : -25 +65 Co
Colour : White RAL 9010
IP Ingress Protection : IP40

Additional Features

UV resistant
Easy install, paintable, non-flammable,
Economic and adaptable
Resistant to acids, oils and greases
Non-conductive
Nonflammable

Important:

The label size area of Ab group cable trunking **without adhesive tape** is GREY on the box.

PVC Trunking

Пластмасови кабелни скари



PT N...

CODE	SIZE	Length	PACKAGING TYPE PAKETLEME TIPI	IN PACK QUANTITY PAKET İÇİ	VOLUME OF PACK KOLI HACMI	WEIGHT OF PACK KOLİ AĞIRLIĞI
	EBAT	UZUNLUK				
	mm	mm		m	m ³	kg
PT 1212 N	12x12	2000	in nylon box	200	0,029	11,1
PT 1510 N	15x10	2000	in nylon box	200	0,030	11,7
PT 1616 N	16x16	2000	in nylon box	100	0,026	7,9
PT 2010 N	20x10	2000	in nylon box	100	0,020	8,2
PT 2013 N	20x13	2000	in nylon box	100	0,026	8,2
PT 2020 N	20x20	2000	in nylon box	100	0,040	10,5
PT 2516 N	25x16	2000	in nylon box	100	0,040	11,9
PT 2525 N	25x25	2000	in nylon box	50	0,031	7,4
PT 3020 N	30x20	2000	in nylon box	50	0,030	7,6
PT 4016 N	40x16	2000	in nylon box	50	0,032	9,1
PT 4025 N	40x25	2000	in nylon box	50	0,050	10,9
PT 4040 N	40x40	2000	in nylon box	48	0,077	13,3
PT 6040 N	60x40	2000	in nylon box	36	0,086	14,3
PT 6060 N	60x60	2000	in nylon box	24	0,086	11,6
PT 8040 N	80x40	2000	in nylon box	16	0,051	8,2
PT 8060 N	80x60	2000	in nylon box	16	0,077	9,6
PT 10040 N	100x40	2000	in nylon box	16	0,064	11,5
PT 10060 N	100x60	2000	in nylon box	12	0,072	9,9
PT 12060 N	120x60	2000	in nylon box	8	0,058	8,4

Adhesive PVC Trunking

(Лепило) ПВЦ кабелни скари

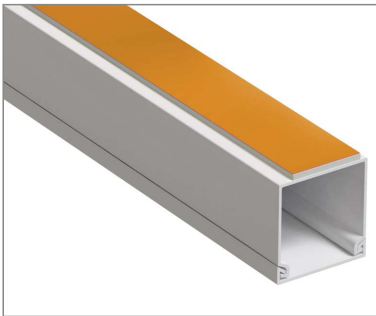

APT NS...

CODE	SIZE	Length	PACKAGING TYPE PAKETLEME TIPI	IN PACK QUANTITY PAKET İÇİ	VOLUME OF PACK KOLI HACMI	WEIGHT OF PACK KOLİ AĞIRLIĞI
	EBAT	UZUNLUK				
	mm	mm		m	m ³	kg
APT 1212 NS	12x12	2000	in nylon box	200	0,029	11,4
APT 1510 NS	15x10	2000	in nylon box	200	0,030	12,1
APT 1616 NS	16x16	2000	in nylon box	100	0,026	8,1
APT 2010 NS	20x10	2000	in nylon box	100	0,020	8,4
APT 2013 NS	20x13	2000	in nylon box	100	0,026	8,4
APT 2020 NS	20x20	2000	in nylon box	100	0,040	10,7
APT 2516 NS	25x16	2000	in nylon box	100	0,040	12,3
APT 2525 NS	25x25	2000	in nylon box	50	0,031	7,6
APT 3020 NS	30x20	2000	in nylon box	50	0,030	7,8
APT 4016 NS	40x16	2000	in nylon box	50	0,032	9,4
APT 4025 NS	40x25	2000	in nylon box	50	0,050	11,2
APT 4040 NS	40x40	2000	in nylon box	48	0,077	13,6
APT 6040 NS	60x40	2000	in nylon box	36	0,086	14,7
APT 6060 NS	60x60	2000	in nylon box	24	0,086	11,8

PT... N

Nylon Bag Packaging

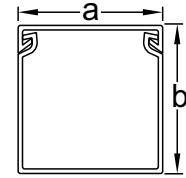

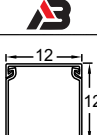
ÜRÜN KODU Code of Item Код Продукта	PT 1212	
Ölçü Size Размер	12*12 mm	
Adet Quantity Количество	378 mt	
Koli Ağırlığı Box Weight Вес в коробе	21,79 kg	
ÜRÜN ADI Description Описание	PVC Kablo Kanalı PVC cable trunking Пластиковые короба	Kutulu In box в коробе
12 X 12		

General features

Row Material PVC UL94, V0 M1
Impact Resistance : 2 Joule
Operation Temperature : -25 +65 Co
Colour : White RAL 9010
IP Ingress Protection : IP40

Additional Features

UV resistant
Easy install, paintable, non-flammable
Economic and adaptable
Resistant to acids, oils and greases
Non-conductive
Nonflammable

Important:

The label size area of AB group cable trunking **without adhesive tape** is GREY on the box.

APT... NS

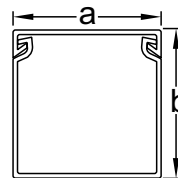

Product with yellow adhesive / Nylon Package

ÜRÜN KODU Code of Item Код Продукта	APT 25X16 NS	
Ölçü Size Размер	25x16	
Adet Quantity Количество	100 mt	
Koli Ağırlığı Box Weight Вес в коробе	20,50	
ÜRÜN ADI Description Описание	PVC Kablo Kanalı PVC Cable Trunking	Kutulu In Box
25x16		

General features

Row Material PVC UL94, V0 M1
Impact Resistance : 2 Joule
Operation Temperature : -25 +65 Co
Colour : White RAL 9010
IP Ingress Protection : IP40

Additional Features

UV resistant
Easy install, paintable, non-flammable,
Economic and adaptable
Resistant to acids, oils and greases
Non-conductive
Nonflammable

Important:

The label size area of AB group cable trunking **without adhesive tape** is GREY on the box.

Modular System Cable Trays

Модулни системни кабелни скари

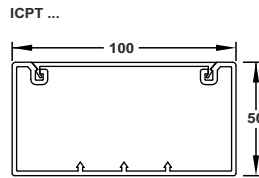
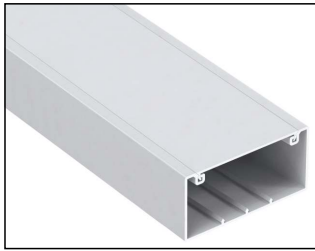

CODE	SIZE	LENGTH	PACKAGING	IN PACK QUANTITY	VOLUME OF PACK	WEIGHT OF PACK
	EBAT	UZUNLUK (L)				
	mm	mm		m	m3	kg
ICPT 10050	100x50	2000	in box	24	0,100	21,6
ICPT 10050.29	100x50	2900	in nylon bag	11,6	0,058	12,6

Accessories

Аксесоари



CODE	DESCRIPTION OF GOODS		SIZE	IN PACK QUANTITY	VOLUME OF PACK	WEIGHT OF PACK
	EN	TR				
			mm	m/pc	m3	kg
ICPT 10050 SE	Partition	Ara bölme	100x50	150 m	0,075	19,6
ICPT 10050 EC	External Corner	Dış köşe	100x50	8 pc	0,0094	0,9
ICPT 10050 IC	Internal Corner	İç Köşe	100x50	8 pc	0,0100	0,6
ICPT 10050 LC	L Shaped Corner	L Dirsek	100x50	10 pc	0,0136	1,0
ICPT 10050 TC	T Shaped Corner	T Dirsek	100x50	10 pc	0,0136	1,0
ICPT 10050 JO	Joint	Birleştirme Elemanı	100x50	100 pc	0,0100	1,6
ICPT 10050 EN	Ending	Sonlandırma Kapağı	100x50	40 pc	0,0040	0,7

Socket Sets

Комплекти фасунги



CODE	DESCRIPTION OF GOODS		FOR SOCKET SIZE	IN PACK QUANTITY	VOLUME OF PACK	WEIGHT OF PACK
	EN	TR				
			mm	pc	m3	kg
PS 11	Single Frame	Tekli Çerçeve	45x45	20	0,006	1,12
PS 12	Double Frame	İkili Çerçeve	45x45	14	0,006	1,07
PS 13	Triple Frame	Üçlü Çerçeve	45x45	12	0,006	1,08
PS 14	Quartet Frame	Dörtlü Çerçeve	45x45	10	0,006	1,18

Socket Sets (British Norm)

Комплекти гнезда (британска норма)



CODE	DESCRIPTION OF GOODS		FOR SOCKET SIZE	IN PACK QUANTITY	VOLUME OF PACK	WEIGHT OF PACK
	EN	TR				
			mm	pc	m3	kg
PSI 15	Single Socket Base	Priz Tabanı (Tek)	SNG BS	200	0,040	3,85
PSI 16	Double Socket Base	Priz Tabanı (Çift)	DBL BS	100	0,040	2,48
PSI 17	Double High Socket Base	Priz Tabanı (Çiftli Yüksek)	2x SNG BS	94	0,032	5,07

ACCESSORIES (MOUNTING SAMPLES)

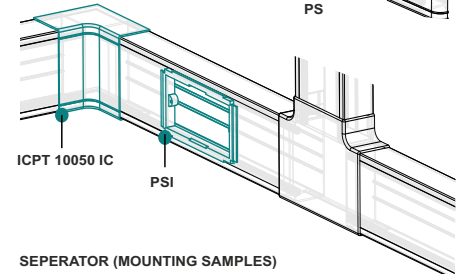
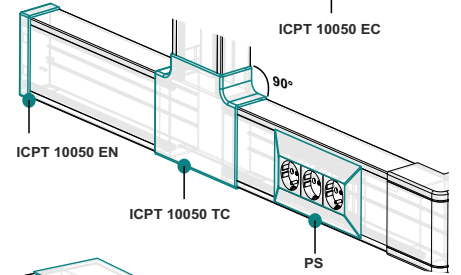
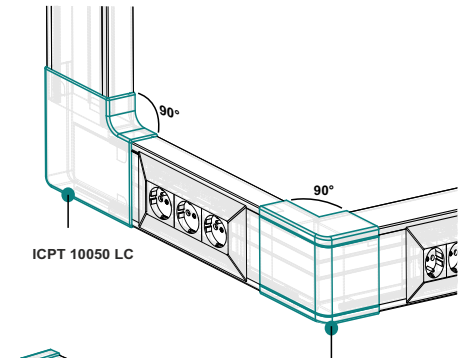

SEPERATOR (MOUNTING SAMPLES)

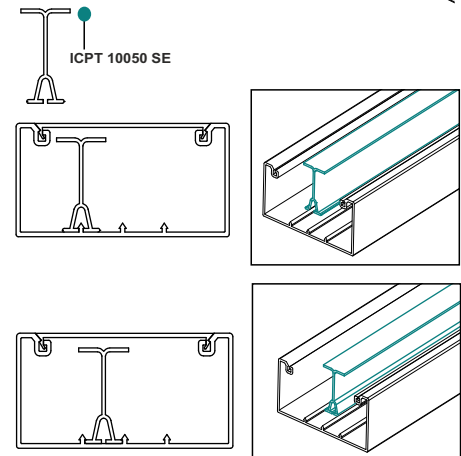

Technical Properties

Raw Material	PVC UL94, VO M1
Impact Resistance	2 Joule
Ip Rating	IP40
Colour	White RAL 9010
Temperature Resistance	-25 C / +65 C

Additional Features

- UV resistance
- Easy install, paintable
- Economic and adaptable
- Resistant to acidics, oils and greases
- Non-conductive
- Non-flammable

Floor Type Cable Trunkings

Подови кабелни скари



DPT...

CODE	SIZE	Length	PACKAGING TYPE	IN PACK QUANTITY	VOLUME OF PACK	WEIGHT OF PACK
	EBAT	UZUNLUK				
	mm	mm		m	m ³	kg
DPT 5012	50x12	2000	in box	80	0,055	23,20
DPT 6015	60x15	2000	in box	60	0,055	21,60
DPT 7518	75x18	2000	in box	32	0,055	17,60
DPT 9020	90x20	2000	in box	24	0,055	16,60

Adhesive Type

ADPT 5012	50x12	2000	in box	80	0,055	23,20
ADPT 6015	60x15	2000	in box	60	0,055	21,60
ADPT 7518	75x18	2000	in box	32	0,055	17,60
ADPT 9020	90x20	2000	in box	24	0,055	16,60

Slotted Cable Trunking

Кабелни скари с прорези (тип панел)

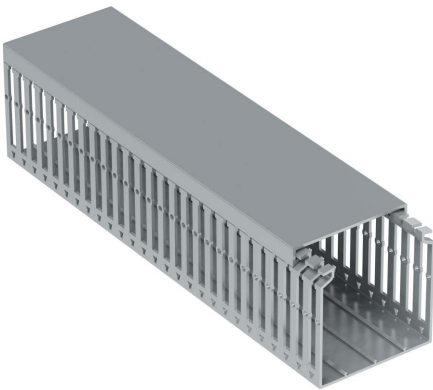

DMT...

CODE	SIZE	Length	PACKAGING TYPE	IN PACK QUANTITY	VOLUME OF PACK	WEIGHT OF PACK
	EBAT	UZUNLUK				
	mm	mm		m	m ³	kg
DMT 2525	25x25	2000	in box	120	0,082	24,72
DMT 2540	25x40	2000	in box	100	0,082	26,74
DMT 2560	25x60	2000	in box	60	0,082	22,80
DMT 4040	40x40	2000	in box	52	0,082	19,38
DMT 4060	40x60	2000	in box	36	0,082	17,87
DMT 4080	40x80	2000	in box	48	0,082	28,05
DMT 6040	60x40	2000	in box	36	0,082	18,66
DMT 6060	60x60	2000	in box	48	0,109	29,56
DMT 6080	60x80	2000	in box	36	0,094	25,50
DMT 8060	80x60	2000	in box	32	0,109	23,55
DMT 8080	80x80	2000	in box	24	0,082	20,52
DMT 10060	100x60	2000	in box	24	0,082	22,92
DMT 120x60	120x60	2000	in box	16	0,082	19,11

DPT...
ADPT...

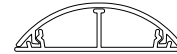

50X12

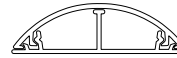

60X15



75X18

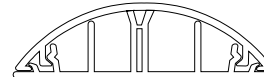

90X20

Technical Properties

Raw Material	PVC UL94, VO M1
Colour	RAL 7045 GREY
Temperature Resistance	-25 C / +60 C

Additional Features

UV resistance
Easy install, paintable
Economic and adaptable
Resistant to acids, oils and greases
Non-conductive
Non-flammable

DMT...

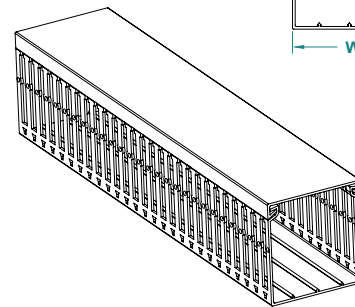
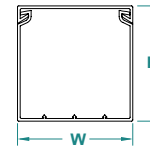

Technical Properties

Raw Material	PVC UL94, VO M1
Colour	RAL 9030 GREY
Temperature Resistance	-25 C / +60 C

Additional Features

UV resistance
Easy install, paintable
Economic and adaptable
Resistant to acids, oils and greases
Non-conductive
Non-flammable